

REV	ECN	CONTENT	CHECK	DATE
V0.0		初版发行	YZG	2017.03.12
V1.0		整理图纸	WL	2019.09.25

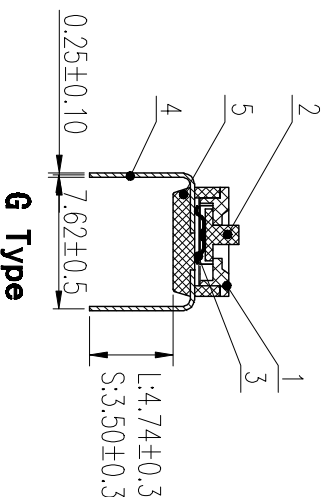

- 技术要求:**
- 额定电流: 25mA, 24VDC (开与关切换时) 100mA, 50VDC (开与关不切换时)
 - 接触阻抗: $\leq 50m\Omega$ (初始), $\leq 100m\Omega$ (寿命测试后)
 - 绝缘电阻: $\geq 100M\Omega / 500VDC$
 - 耐电压: 500VAC/1minute
 - 拨动力: 1000g max
 - 拨动行程: 0.9mm
 - 机械寿命: ≥ 2000 cycles
 - 电气寿命: ≥ 2000 cycles/25mA, 24VDC
 - 使用温度: $-40^{\circ}C \sim +85^{\circ}C$
 - 存储温度: $-40^{\circ}C \sim +85^{\circ}C$
 - 符合RoHS要求

焊接说明:
 波峰焊接: $260 \pm 5^{\circ}C$, 5S max
 手工焊接: 30W电烙铁, $320 \pm 5^{\circ}C$, 3S max
 焊接前保持开关在“OFF”状态

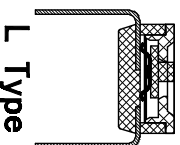
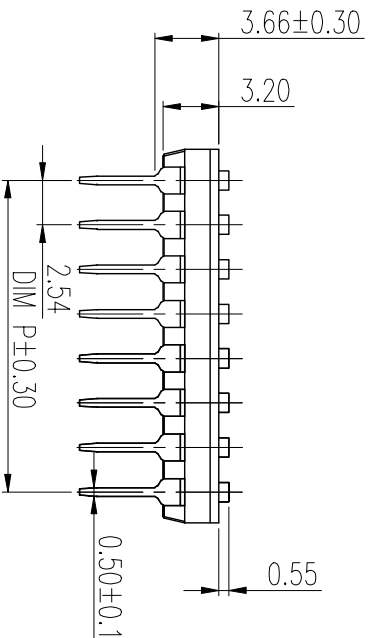
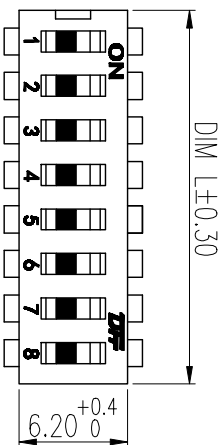
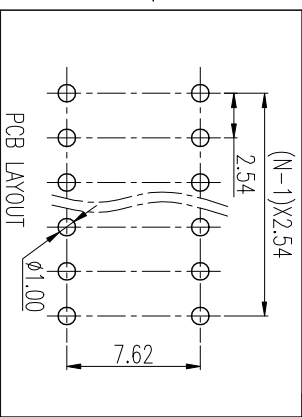
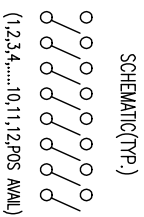
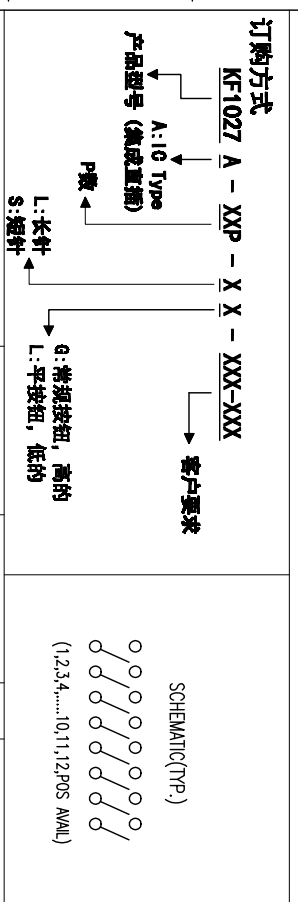

Poles	Dim P	Dim L
1P	—	3.54
2P	2.54	6.08
3P	5.08	8.62
4P	7.62	11.16
5P	10.16	13.70
6P	12.70	16.24
7P	15.24	18.78
8P	17.78	21.32
9P	20.32	23.86
10P	22.86	26.40
11P	25.40	28.94
12P	27.94	31.48

序号	零件名称	零件编码	数量	材质	备注
1	盖板	\	1	工程塑料	U1.94V-0
2	拨柄	\	P	工程塑料	U1.94V-0
3	弹片	\	P	铜合金	触点镀金
4	PTIN针	\	2P	铜合金	镀金
5	底座	\	1	工程塑料	U1.94V-0
6	高温薄膜	\	1	POLYIMIDE	黄色

APP.	DATE	NAME	UNITS	SCALE	SHEET	PROJECTION-METHOD
CHK. <td>DATE</td> <td>KF1027A-XXP-XX-DFT-XXX</td> <td>MM</td> <td>1:1</td> <td>1/1</td> <td>①</td>	DATE	KF1027A-XXP-XX-DFT-XXX	MM	1:1	1/1	①
DWG. <td>DATE</td> <td></td> <td></td> <td></td> <td></td> <td></td>	DATE					
	DWGNO.					
		W20000101				

General tolerance in mm		radii and chamfers		shorter angle side		over	
over	to	over	to	over	to	over	to
±0.15	±0.2	±0.25	±0.3	±0.5	±1.0	±30'	±20'
0.5	3	6	30	120	400	1000	4000
3	6	30	120	400	1000	4000	10000

订购方式	客户要求	SCHEMATIC(TYP)
KF1027 A - XXP - X X - XXX-XXX		(1,2,3,4,...;10,11,12;POS AVAL)

DF 慈溪市凯峰电子有限公司
 CIXI KAIFENG ELECTRONICS CO., LTD